

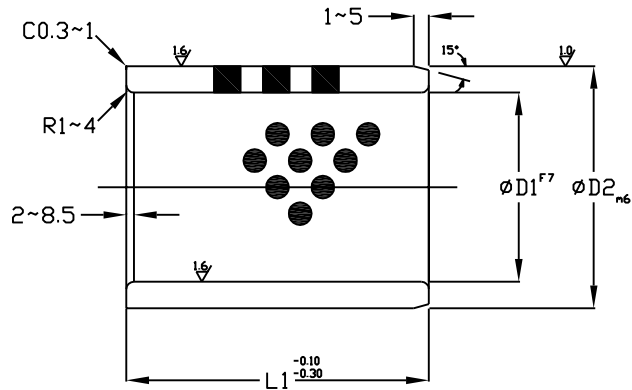

商帥企業有限公司

BF Bearing Enterprise



Straight Bushing - Self-Lubricating					
BF Bearing Code	D1	D1 Tol F7	D2	D2 Tol m6	L1 Overall Length
50A-081208	8	+0.028 +0.013	12		08
50A-081210					10
50A-081212					12
50A-081215					15
50A-101408					10
50A-101410	10				
50A-101412	12				
50A-101415	15				
50A-101420	20				
50A-121808	12	+0.034 +0.016	18	+0.018 +0.007	08
50A-121810					10
50A-121812					12
50A-121815					15
50A-121816					16
50A-121819					19
50A-121820					20
50A-121825					25
50A-121830					30
50A-131910					13
50A-131912	12				
50A-131915	15				
50A-131920	20				
50A-142010	14	+0.034 +0.016	20	+0.021 +0.008	
50A-142012					12
50A-142015					15
50A-142020					20
50A-142025					25
50A-142030					30

Straight Bushing - Self-Lubricating					
BF Bearing Code	D1	D1 Tol F7	D2	D2 Tol m6	L1 Overall Length
50A-152110	15		21		10
50A-152112					12
50A-152115					15
50A-152116					16
50A-152120					20
50A-152125					25
50A-162210	16	+0.034 +0.016	22	+0.021 +0.008	10
50A-162212					12
50A-162215					15
50A-162216					16
50A-162219					19
50A-162220					20
50A-162225					25
50A-162230					30
50A-162235					35
50A-162240					40
50A-172315	17		23		15
50A-182412	18		24		12
50A-182415					15
50A-182416					16
50A-182420					20
50A-182425					25
50A-182430					30
50A-192615	19	+0.041 +0.020	26		15
50A-192620					20
50A-202810					10
50A-202812	20		28		12



商帥企業有限公司

BF Bearing Enterprise

Straight Bushing - Self-Lubricating

BF Bearing Code	D1	D1 Tol F7	D2	D2 Tol m6	L1 Overall Length		
50A-202815	20		28	+ 0.021 + 0.008	15		
50A-202816					16		
50A-202819					19		
50A-202820					20		
50A-202825					25		
50A-202830					30		
50A-202835					35		
50A-202840			40				
50A-202850			50				
50A-203016			30			30	16
50A-203020							20
50A-203025							25
50A-203030							30
50A-203035							35
50A-203040	40						
50A-223212	22			32			12
50A-223215			15				
50A-223220			20				
50A-223225	25	+0.041 +0.020	33	25			
50A-253312				12			
50A-253315				15			
50A-253316				16			
50A-253320				20			
50A-253325				25			
50A-253330				30			
50A-253335			35				
50A-253340			40				
50A-253350			50				
50A-253360			60				
50A-253512			35		35	+ 0.025 + 0.009	12
50A-253515						15	
50A-253516						16	
50A-253520	20						
50A-253525	25						
50A-253530	30						
50A-253535	35						
50A-253540	40						
50A-253550	50						
50A-283820	28		38	20			
50A-283825				25			
50A-283830				30			
50A-283840				40			

Straight Bushing - Self-Lubricating

BF Bearing Code	D1	D1 Tol F7	D2	D2 Tol m6	L1 Overall Length				
50A-303812	30		38		12				
50A-303815					15				
50A-303820					20				
50A-303825					25				
50A-303830					30				
50A-303835					35				
50A-303840					40				
50A-303850					50				
50A-303860					60				
50A-304012					40		40	+0.041 +0.020	12
50A-304015								15	
50A-304020								20	
50A-304025								25	
50A-304030								30	
50A-304035	35								
50A-304040	40								
50A-304050	31.5				50				
50A-304060					60				
50A-314030					30				
50A-314040					40				
50A-324220					42		42	+ 0.025 + 0.009	20
50A-324230								30	
50A-324240								40	
50A-354420					44		44		20
50A-354425									25
50A-354430									30
50A-354435									35
50A-354440									40
50A-354450									50
50A-354460									60
50A-354520	35		45	+0.050 +0.025	20				
50A-354525				25					
50A-354530				30					
50A-354535				35					
50A-354540				40					
50A-354550				50					
50A-354560				60					
50A-384840	38		48		40				
50A-405015	40					50		15	
50A-405020								20	
50A-405025								25	
50A-405030		30							



商帥企業有限公司

BF Bearing Enterprise

Straight Bushing - Self-Lubricating

BF Bearing Code	D1	D1 Tol F7	D2	D2 Tol m6	L1 Overall Length				
50A-405035	40		50	+ 0.025 + 0.009	35				
50A-405040					40				
50A-405050					50				
50A-405060					60				
50A-405070					70				
50A-405080					80				
50A-405515			45	+0.050 +0.025	55		15		
50A-405530							30		
50A-405535							35		
50A-405540							40		
50A-405550							50		
50A-405560							60		
50A-455530					50		56		30
50A-455535									35
50A-455540	40								
50A-455550	50								
50A-455560	60								
50A-455630	30								
50A-455635	35								
50A-455640	40								
50A-455650	50								
50A-455660	60								
50A-456030	60		60				30		
50A-456035							35		
50A-456040							40		
50A-456050							50		
50A-456060					60				
50A-456070					70				
50A-456080			80						
50A-506020			50		62		20		
50A-506030							30		
50A-506035							35		
50A-506040							40		
50A-506050							50		
50A-506060							60		
50A-506070					70				
50A-506080	80								
50A-506230							30		
50A-506235							35		
50A-506240							40		
50A-506250							50		
50A-506260							60		

Straight Bushing - Self-Lubricating

BF Bearing Code	D1	D1 Tol F7	D2	D2 Tol m6	L1 Overall Length				
50A-506270	50	+0.050 +0.025	62		70				
50A-506530			30						
50A-506540			40						
50A-506550			50						
50A-506560			60						
50A-506570			70						
50A-506580			80						
50A-5065100			100						
50A-557030			55			70		30	
50A-557035								35	
50A-557040	40								
50A-557050	50								
50A-557060	60								
50A-557070	70								
50A-607430	60	+0.060 +0.030		74				+ 0.030 + 0.011	30
50A-607435									35
50A-607440									40
50A-607450									50
50A-607460			60						
50A-607470			70						
50A-607480			80						
50A-607530			30						
50A-607535			35						
50A-607540			40						
50A-607550	50								
50A-607560	60								
50A-607570	70								
50A-607580	80								
50A-6075100	100								
50A-637560	63		75		60				
50A-637570					70				
50A-637580					80				
50A-658040	65		80		40				
50A-658050					50				
50A-658060					60				
50A-658070					70				
50A-658080					80				
50A-708530					70		85	+ 0.035 + 0.013	30
50A-708535	35								
50A-708540	40								
50A-708550	50								
50A-708560	60								



商帥企業有限公司

BF Bearing Enterprise

Straight Bushing - Self-Lubricating					
BF Bearing Code	D1	D1 Tol F7	D2	D2 Tol m6	L1 Overall Length
50A-708570	70		85		70
50A-708580					80
50A-7085100					100
50A-709050					50
50A-709060			60		
50A-709070			70		
50A-709080			80		
50A-759050			75		+0.060 +0.030
50A-759060	60				
50A-759070	70				
50A-759080	80				
50A-7590100	100				
50A-759560	60				
50A-759570	70				
50A-759580	80				
50A-7595100	100				
50A-809640	80		95		40
50A-809650					50
50A-809660					60
50A-809670					70
50A-809680			80		
50A-8096100			100		
50A-8096120			120		
50A-8010040			100		
50A-8010050	50				
50A-8010060	60				
50A-8010070	70				
50A-8010080	80				
50A-80100100	100				
50A-80100120	120				
50A-80100140	140				
50A-8510060	85	+0.071 +0.036			60
50A-8510080					80
50A-9011050	90		110		50
50A-9011060					60
50A-9011080					80

Straight Bushing - Self-Lubricating					
BF Bearing Code	D1	D1 Tol F7	D2	D2 Tol m6	L1 Overall Length
50A-9011090	90		110		90
50A-90110100					100
50A-90110120					120
50A-10012050					50
50A-10012060	100		120	+0.035 +0.013	60
50A-10012070					70
50A-10012080					80
50A-10012090					90
50A-100120100					100
50A-100120120					120
50A-100120140					140
50A-11013050					110
50A-11013070	70				
50A-11013080	80				
50A-110130100	100				
50A-110130120	120				
50A-12014070	120		140		70
50A-12014080					80
50A-12014090					90
50A-120140100					100
50A-120140120	120				
50A-120140140	140				
50A-125145100	125		145	+0.040 +0.015	100
50A-125145120					120
50A-13015080	130		150		80
50A-130150100					100
50A-130150130					130
50A-140160100	140	+0.083 +0.043	160		100
50A-140160140					140
50A-15017080	150		170		80
50A-150170100					100
50A-150170150					150
50A-16018080	160		180		80
50A-160180100					100
50A-160180150					150

NOTE:

Evenly distributed graphite to cover 20-30% of the sliding surface.
 Graphite to be positioned to insure overlapping in the sliding direction.
 Bushings require initial lubrication with light oil. Do not use grease!



商帥企業有限公司

BF Bearing Enterprise

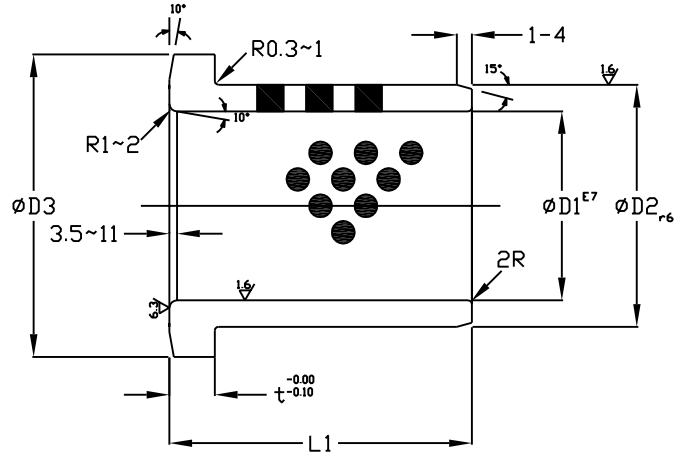

Flanged Bushing - Self-Lubricating								
BF Bearing Code	D1	D1 Tol E7	D2	D2 Tol r6	D3	t	L1 Overall Length	
50AF-0810	8	+0.040 +0.025	12	+ 0.034 + 0.023	20	2	10	
50AF-0815							15	
50AF-1010	10		14		22		10	
50AF-1012							12	
50AF-1015			15					
50AF-1017			17					
50AF-1020		20						
50AF-1210	12	+0.050 +0.032	18	+ 0.041 + 0.028	25	3	10	
50AF-1215							15	
50AF-1220			20					
50AF-1225			25					
50AF-1230			30					
50AF-1315	13		19		26		15	
50AF-1320								20
50AF-1415	14		20		27		15	
50AF-1420								20
50AF-1425								25
50AF-1510		10						
50AF-1515	15	21	28	15				
50AF-1520					20			
50AF-1525					25			
50AF-1530					30			
50AF-1615					16	22	29	15
50AF-1618	18							
50AF-1620	20							
50AF-1623	23							



商帥企業有限公司

BF Bearing Enterprise

Flanged Bushing - Self-Lubricating							
BF Bearing Code	D1	D1 Tol E7	D2	D2 Tol r6	D3	t	L1 Overall Length
50AF-1625	16	+0.050 +0.032	22	+ 0.041 + 0.028	29	3	25
50AF-1630							30
50AF-1635							35
50AF-1640							40
50AF-1820	18		24		32		20
50AF-1830							30
50AF-2015	20		30		40		15
50AF-2020							20
50AF-2025							25
50AF-2030							30
50AF-2035							35
50AF-2040							40
50AF-2515	25	+0.061 +0.040	35		45		15
50AF-2520							20
50AF-2525							25
50AF-2530							30
50AF-2535							35
50AF-2540							40
50AF-2550	50						
50AF-3020	30		40	+ 0.050 + 0.034	50	5	20
50AF-3025							25
50AF-3030							30
50AF-3035							35
50AF-3040							40
50AF-3050							50
50AF-3120	31.5						20
50AF-3130							30
50AF-3135							35
50AF-3140							40
50AF-3520	35	+0.075 +0.050	45		60		20
50AF-3525							25
50AF-3530							30
50AF-3535							35
50AF-3540							40
50AF-3550							50
50AF-4020	40		50		65		20
50AF-4025							25
50AF-4030							30

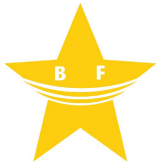

商帥企業有限公司

BF Bearing Enterprise

Flanged Bushing - Self-Lubricating								
BF Bearing Code	D1	D1 Tol E7	D2	D2 Tol r6	D3	t	L1 Overall Length	
50AF-4035	40	+0.075 +0.050	50	+ 0.050 + 0.034	65	5	35	
50AF-4040							40	
50AF-4050							50	
50AF-4530	45		55	70	30			
50AF-4535					35			
50AF-4540					40			
50AF-4550					50			
50AF-4560	50		60	75	+ 0.060 + 0.041		7.5	60
50AF-5030								30
50AF-5035								35
50AF-5040		40						
50AF-5050	55	+0.090 +0.060	60	80	7.5	50		
50AF-5060						60		
50AF-5540						40		
50AF-5560						60		
50AF-6040	60	75	85	+ 0.062 + 0.043	7.5	40		
50AF-6050						50		
50AF-6060						60		
50AF-6080						80		
50AF-6367	63	+0.107 +0.072	80	95	10	67.5		
50AF-6560	65					60		
50AF-7050	70					50		
50AF-7080	80					80		
50AF-7560	75	100	90	+ 0.073 + 0.051	7.5	60		
50AF-8060	80					120	110	60
50AF-8080								80
50AF-80100								100
50AF-9060	90	110	120	+ 0.076 + 0.054	10	60		
50AF-9080	100					130	150	80
50AF-10080								80
50AF-100100								100
50AF-12080	120	140	170	+ 0.088 + 0.063	10	80		
50AF-120100						100		

NOTE:

Evenly distributed graphite to cover 20-30% of the sliding surface.
 Graphite to be positioned to insure overlapping in the sliding direction.
 Bushings require initial lubrication with light oil. Do not use grease!



商帥企業有限公司

BF Bearing Enterprise

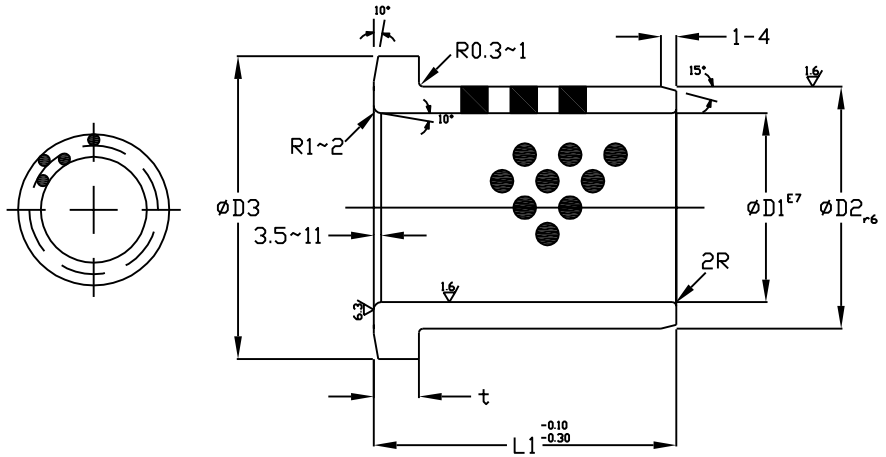

Shoulder Bushing w/ Lubricant on Flange - Self Lubricating									
BF Bearing Code	D1	D1 Tol E7	D2	D2 Tol r6	D3	D3 Tol	t	t tol	L1 Overall Length
50AFG-1211	12		18	+0.034 +0.023	30				11
50AFG-1223									23
50AFG-1513	15	+0.050 +0.032	21	+0.041 +0.028	35		3		13
50AFG-1613	16		22						18
50AFG-1618		18		24		40			
50AFG-1818	18		24		40				18
50AFG-2020	20		28		45				20
50AFG-2025									25
50AFG-2520	25	+0.061 +0.041	33		50		5	0 -0.03	20
50AFG-2525									25
50AFG-3025	30		38		55				25
50AFG-3035									35
50AFG-3525	35		44	+0.050 +0.034	65	0 -0.03			25
50AFG-3535									35
50AFG-4027	40	+0.075 +0.050	50		70		7		27
50AFG-4037									37
50AFG-4047									47
50AFG-5038	50		62	+0.060 +0.041	90		8		38
50AFG-5048									48
50AFG-5058									58
50AFG-6038	60		74		110			0 -0.04	38
50AFG-6068									68
50AFG-7050	70	+0.090 +0.060	85	+0.073 +0.051	120		10		50
50AFG-7080									80
50AFG-8060									60
50AFG-8090	80		96		140				90

NOTE:

Evenly distributed graphite to cover 20-30% of the sliding surface.
 Graphite to be positioned to insure overlapping in the sliding direction.
 Bushings require initial lubrication with light oil. Do not use grease!



商帥企業有限公司

BF Bearing Enterprise

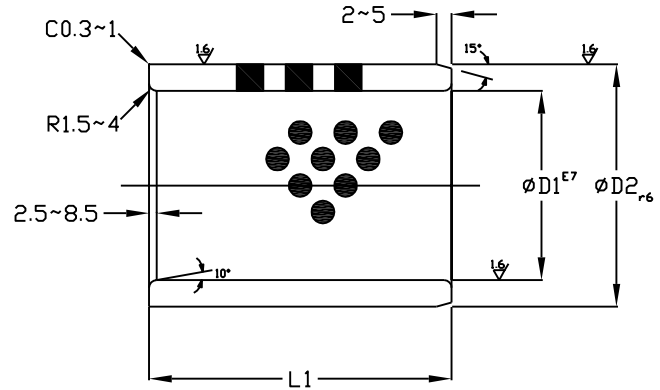

Waterproof Straight Bushing - Self-Lubricating					
BF Bearing Code	D1	D1 Tol E7	D2	D2 Tol r6	L1 Overall Length
50A4-121820	12	+0.050 +0.032	18	+0.034 +0.023	20
50A4-152120	15		21		20
50A4-162220	16		22		20
50A4-162230			22		30
50A4-182420	18		24		+0.041 +0.028
50A4-203020	20	30	20		
50A4-203030			30		
50A4-203040			40		
50A4-253520	25	+0.061 +0.040	35	+0.050 +0.034	20
50A4-253525					25
50A4-253530					30
50A4-253540					40
50A4-253550					50
50A4-304020	30	+0.061 +0.040	40	+0.050 +0.034	20
50A4-304025					25
50A4-304030					30
50A4-304040					40
50A4-304050					50
50A4-354520	35	+0.075 +0.050	45	+0.050 +0.034	20
50A4-354530					30
50A4-354535					35
50A4-354540					40
50A4-354550					50
50A4-405030	40	+0.075 +0.050	50	+0.050 +0.034	30
50A4-405040					40
50A4-405050					50
50A4-405060					60

Waterproof Straight Bushing - Self-Lubricating					
BF Bearing Code	D1	D1 Tol E7	D2	D2 Tol r6	L1 Overall Length
50A4-405540	40	+0.075 +0.050	55	+0.060 +0.041	40
50A4-405550					50
50A4-405560					60
50A4-456030	45	+0.075 +0.050	60	+0.060 +0.041	30
50A4-456050					50
50A4-456060	50	+0.075 +0.050	60	+0.060 +0.041	60
50A4-506040					40
50A4-506050					50
50A4-506060					60
50A4-506540					40
50A4-506550	50	+0.075 +0.050	65	+0.062 +0.043	50
50A4-506560					60
50A4-506570					70
50A4-557040	55	+0.090 +0.060	70	+0.062 +0.043	40
50A4-557060					60
50A4-557070					70
50A4-607550	60	+0.090 +0.060	75	+0.062 +0.043	50
50A4-607560					60
50A4-607570					70
50A4-607580					80
50A4-658060					60
50A4-658070	65	+0.090 +0.060	80	+0.062 +0.043	70
50A4-658080					80
50A4-709060	70	+0.090 +0.060	90	+0.073 +0.051	60
50A4-709070					70
50A4-709080					80
50A4-709090					90
50A4-709100					100



商帥企業有限公司

BF Bearing Enterprise

Waterproof Straight Bushing - Self Lubricating							
BF Bearing Code	D1	D1 Tol F7	D2	D2 Tol m6	L1 Overall Length		
50A4-759570	75	+0.090 +0.060	95	+ 0.073 + 0.051	70		
50A4-7595100					100		
50A4-8010060	80		100		+ 0.076 + 0.054	60	
50A4-8010080						80	
50A4-8010090			90				
50A4-80100100			100				
50A4-80100110			110				
50A4-9011060	90		+0.107 +0.072		110	+ 0.088 + 0.063	60
50A4-9011080							80
50A4-9011090							90
50A4-90110100	100	120		+ 0.093 + 0.068	100		
50A4-10012060					60		
50A4-10012080					80		
50A4-100120100					100		
50A4-100120120	110	+0.125 +0.085		130	+ 0.093 + 0.068		120
50A4-110130100							100
50A4-110130110							110
50A4-12014080	120		140	+ 0.093 + 0.068		80	
50A4-120140100						100	
50A4-120140120						120	
50A4-130150100	130		+0.125 +0.085	150		+ 0.093 + 0.068	100
50A4-130150130							130
50A4-130150150							150
50A4-140160100	140			160			+ 0.093 + 0.068
50A4-140160140		140					
50A4-150170100	150	170			+ 0.093 + 0.068		
50A4-150170150				150			
50A4-160180100	160			180			+ 0.093 + 0.068
50A4-160180150		150					

NOTE:

Evenly distributed graphite to cover 20-30% of the sliding surface.
 Graphite to be positioned to insure overlapping in the sliding direction.
 Bushings require initial lubrication with light oil. Do not use grease!



商帥企業有限公司

BF Bearing Enterprise

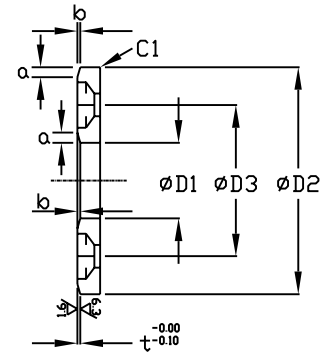
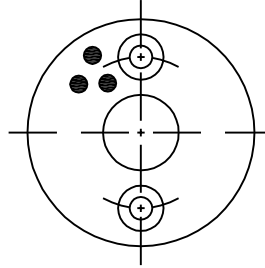

Washer Plate - Self-Lubricating

BF Bearing Code	D1	D1 Tol F7	D2	t	D3	No. Tap	Tap Size	Chamfer a	Chamfer b
50AW-1003	10.2	+0.2 +0.1	30	3	20	2	M3	1.5	0.3
50AW-1203	12.2				28				
50AW-1203N			N/A						
50AW-1303	13.2		40		28	2	M3	2	
50AW-1403	14.2				35				
50AW-1503	15.2		50		N/A				
50AW-1603	16.2			35	M3				
50AW-1603N			N/A						
50AW-1803	18.2		35	2	M5	2.5			
50AW-2005	20.2		40						
50AW-2505	25.2		45						
50AW-3005	30.2		50						
50AW-3505	35.2		70	7	M6	3	0.5		
50AW-4007	40.2		80			4	0.6		
50AW-4507	45.2		90	8	M8	5	0.8		
50AW-5008	50.3		100						
50AW-5508	55.3	110	10	M10	5	0.8			
50AW-6008	60.3	120							
50AW-6508	65.3	125	10	M10	5	0.8			
50AW-7010	70.3	130							
50AW-7510	75.3	140	10	M10	5	0.8			
50AW-8010	80.3	150							
50AW-9010	90.5	170	10	M10	5	0.8			
50AW-10010	100.5	190							
50AW-12010	120.5	200	10	M10	5	0.8			

NOTE:

Evenly distributed graphite to cover 20-30% of the sliding surface.
 Graphite to be positioned to insure overlapping in the sliding direction.
 Bushings require initial lubrication with light oil. Do not use grease!



商帥企業有限公司

BF Bearing Enterprise

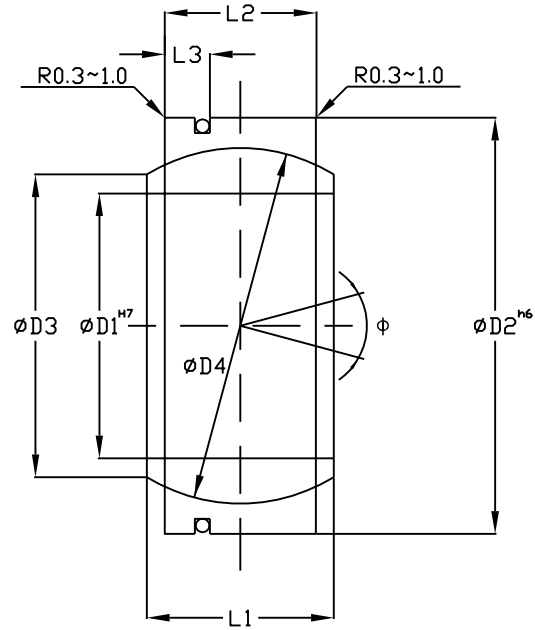

ϕ : Degree of Rotation Allowed

Spherical Bushing w/ Casing - Self-Lubricating

BF Bearing Code	D1	D1 Tol H7	D2	D2 Tol h6	D3	D4	L1	L2	L2 Tol	L3	ϕ	Moving Load N {kgf}	Still Load N {kgf}
50AB-2035	20	+0.021 +0	35	0 -0.011	24	29	16	12	0 -0.2	5	9	9410 {960}	23500 {2400}
50AB-2542	25		42		29	35.5	20	16			7	15600 {1600}	39200 {4000}
50AB-3047	30		47		34	40.7	22	18			6°	21100 {2160}	52900 {5400}
50AB-3555	35	+0.025 +0	55	0 -0.013	40	47	25	20	0 -0.3	6	6°	27400 {2800}	68600 {7000}
50AB-4062	40		62		45	53	28	22			7°	34500 {3520}	86200 {8800}
50AB-4568	45		68		51	60	32	25			44100 {4500}	109000 {11200}	
50AB-5075	50		75		56	66	35	28			54900 {5600}	137000 {14000}	
50AB-6090	60	+0.030 +0	90	0 -0.016	67	80	44	36	0 -0.4	6	6°	84700 {8640}	211000 {21600}
50AB-70105	70		105		78	92	49	40			109000 {11200}	274000 {28000}	
50AB-80120	80		120		89	105	55	45			141000 {14400}	353000 {36000}	
50AB-90130	90	+0.035 +0	130	0 -0.019	98	115	60	50	0 -0.5	7	5	176000 {18000}	441000 {45000}
50AB-100150	100		150		110	130	70	55			7°	215000 {22000}	539000 {55000}
50AB-110160	110		160		121	140	70	55			6°	237000 {24200}	593000 {60500}
50AB-120180	120		180		136	160	85	70			329000 {33600}	823000 {84000}	

NOTE:

Evenly distributed graphite to cover 20-30% of the sliding surface.
 Graphite to be positioned to insure overlapping in the sliding direction.
 Bushings require initial lubrication with light oil. Do not use grease!



商帥企業有限公司 BF Bearing Enterprise

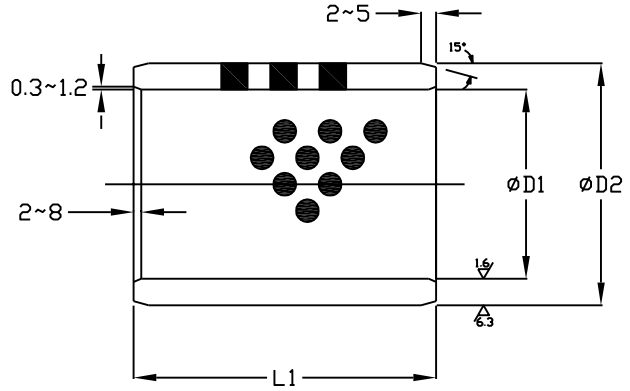

Straight Bushing (Bronze) - Self-Lubricating					
BF Bearing Code	D1	D1 Tol	D2	D2 Tol	L1 Overall Length
50B-203020	20		30	+ 0.049 + 0.028	20
50B-203025					25
50B-203030					30
50B-253520	25	+0.105 +0.072	35		20
50B-253530					30
50B-253540					40
50B-304025	30		40		25
50B-304030					30
50B-304040					40
50B-304225			25		
50B-304230			30		
50B-304240			40		
50B-324230	32		42		30
50B-324240					40
50B-324530					30
50B-324540	35	+0.144 +0.105	45		40
50B-354530					30
50B-354540					40
50B-354550	35		48		50
50B-354830					30
50B-354840					40
50B-354850					50
50B-405030					30
50B-405040	40		50		40
50B-405050					50

Straight Bushing (Bronze) - Self-Lubricating					
BF Bearing Code	D1	D1 Tol	D2	D2 Tol	L1 Overall Length
50B-405530	40		55		30
50B-405540					40
50B-405550					50
50B-455540	45		60		40
50B-455550					50
50B-456040					40
50B-456050	50	+0.144 +0.105	60	+ 0.071 + 0.041	50
50B-506040					40
50B-506050					50
50B-506060			60		
50B-506540			40		
50B-506550			50		
50B-506560	60				
50B-557050	55		70		50
50B-557060					60
50B-557550					50
50B-557560	60		75		60
50B-607550					50
50B-607560					60
50B-607580	60	+0.190 +0.144	80	+ 0.073 + 0.043	80
50B-608050					50
50B-608060					60
50B-608080					80
50B-658060					60
50B-658080	80				
50B-658080	65				80



商帥企業有限公司

BF Bearing Enterprise

Straight Bushing (Bronze) - Self-Lubricating						
BF Bearing Code	D1	D1 Tol	D2	D2 Tol	L1 Overall Length	
50B-658560	65	+0.190 +0.144	85	+ 0.086 + 0.051	60	
50B-658580					80	
50B-708560	70				90	60
50B-708580						80
50B-709060			60			
50B-709080	75		95		100	80
50B-759060						60
50B-759080			80			
50B-759560			60			
50B-759580	80		100		100	80
50B-809560		60				
50B-809580		80				
50B-8095100		100				
50B-8010060		60				
50B-8010080		80				
50B-80100100	100					
50B-8510080	85	105	110	80		
50B-85100100				100		
50B-8510580				80		
50B-85105100				100		
50B-9011080	90	115	115	80		
50B-90110100				100		
50B-9011580				80		
50B-90115100				100		
50B-9511580	95	120	120	80		
50B-95115100				100		
50B-9512080				80		
50B-95120100				100		
50B-10012080	100	125	125	80		
50B-100120100				100		
50B-100120120				120		
50B-10012580				80		
50B-100125100				100		
50B-100125120				120		

NOTE:

Evenly distributed graphite to cover 20-30% of the sliding surface.
 Graphite to be positioned to insure overlapping in the sliding direction.
 Bushings require initial lubrication with light oil. Do not use grease!